







ST 010 108 7811



- 167mm projection
- fixed spout
- rectangular, air-enriched flow
- height of mixer 198 mm
- height up to aerator 133 mm
- hole diameter spout 35 mm
- hole diameter valve 32 mm
- handle Ø 60mm
- 2x screw-in M 8 x 1 pressure hose, leak-tested
- 1x screw-in M 10 x 1 pressure hose, leak-tested
- max. flow 4.5 l/min
- progressive cartridge
- lead-free
- with hot / cold marking
- This product can help a building meet the requirements of Green Building Rating Systems, e.g. LEED®, BREEAM®, DGNB

	Chrome	ST 010 108 7811-00
	Brushed Platinum	ST 010 108 7811-06
	Dark Chrome	ST 010 108 7811-19
	Brushed Durabronze (23kt Gold)	ST 010 108 7811-28
	Platinum / Brushed Platinum	ST 010 108 7811-36
	Durabronze / Brushed Durabronze (23kt Gold)	ST 010 108 7811-38
	Brushed Dark Platinum	ST 010 108 7811-99

**Individual components of this set**

You need the following components for this set

1x 29 218 811-00



1x 11 188 811-00





## CYO Two-hole basin mixer without pop-up waste - Chrome

---

CYO







ST 010 108 7811

ST 010 108 7811



- 167mm projection
- fixed spout
- rectangular, air-enriched flow
- height of mixer 198 mm
- height up to aerator 133 mm
- hole diameter spout 35 mm
- hole diameter valve 32 mm
- handle Ø 60mm
- 2x screw-in M 8 x 1 pressure hose, leak-tested
- 1x screw-in M 10 x 1 pressure hose, leak-tested
- max. flow 4.5 l/min
- progressive cartridge
- lead-free
- This product can help a building meet the requirements of Green Building Rating Systems, e.g. LEED®, BREEAM®, DGNB

NOTE: The handle inserts must be ordered separately from the fittings!

	Chrome	29 218 811-00
	Brushed Platinum	29 218 811-06
	Dark Chrome	29 218 811-19
	Brushed Durabross (23kt Gold)	29 218 811-28
	Platinum / Brushed Platinum	29 218 811-36
	Durabross / Brushed Durabross (23kt Gold)	29 218 811-38
	Brushed Dark Platinum	29 218 811-99

ST 010 108 7811

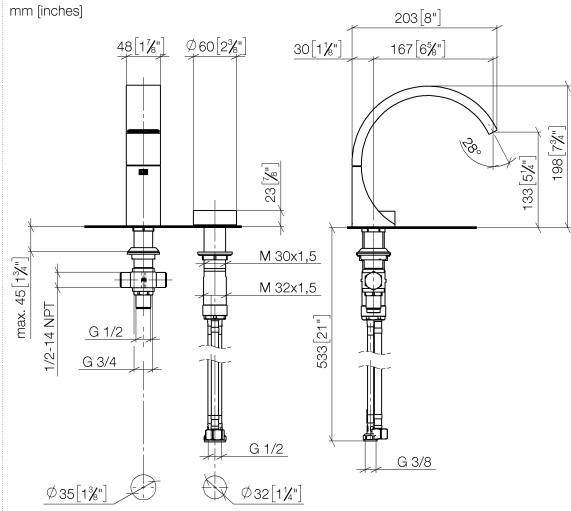

**Flow rate chart**

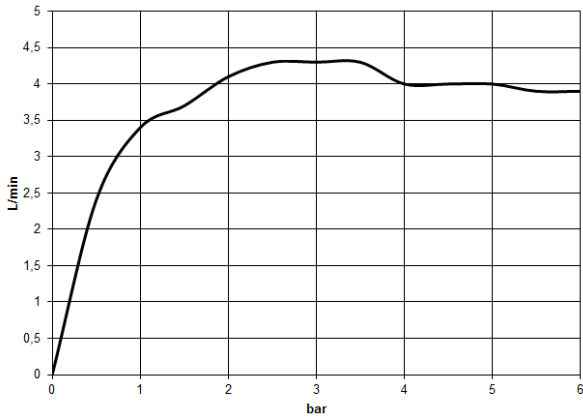

**Certificates**

WRAS\_2201012. LGA\_38103.

ST 010 108 7811

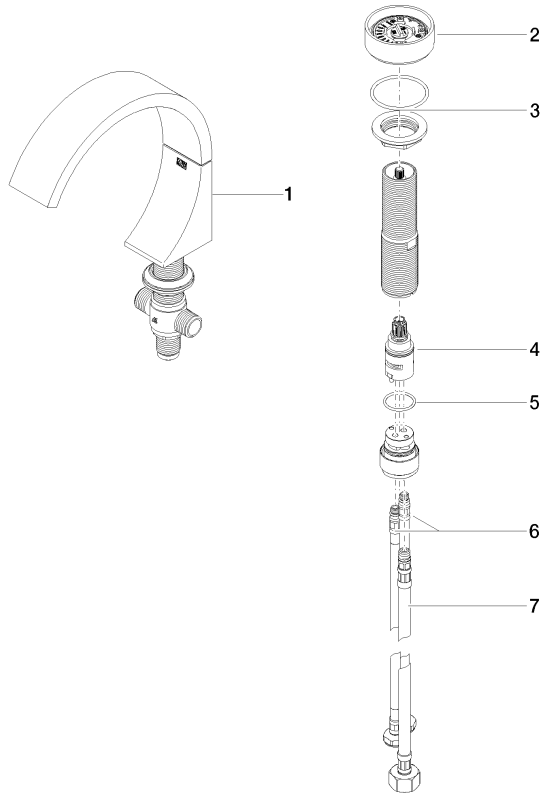







Spare parts list

No.	Item Number	Name	Quantity used	Delivery time
1	13 717 811-00	CYO Deck-mounted basin spout without pop-up waste - Chrome	1	10
2	90 18 40 290 00-00	handle	1	10
3	04 30 11 038 67 90	fixing set	1	2
4	90 90 03 169 00 90	top	1	2
5	09 14 10 112 90	seal	1	2
6	04 30 04 100 00 90	hose	2	2
7	04 30 04 019 00 90	hose	1	2

ST 010 108 7811

- with hot / cold marking
- for two-hole basin mixer



	Chrome	11 188 811-00
	Brushed Platinum	11 188 811-06
	Platinum	11 188 811-08
	Durabress (23kt Gold)	11 188 811-09
	Dark Chrome	11 188 811-19
	Brushed Durabress (23kt Gold)	11 188 811-28
	Brushed Dark Platinum	11 188 811-99



# CYO Two-hole basin mixer without pop-up waste - Chrome

---

CYO

ST 010 108 7811

ST 010 108 7811

mm [inches]

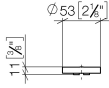





## CYO Two-hole basin mixer without pop-up waste - Chrome

---

CYO

ST 010 108 7811

ST 010 108 7811

Parts for other  
finishes can be found  
here: Brushed  
Platinum

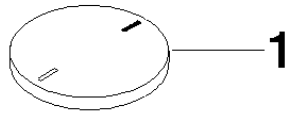



## CYO Two-hole basin mixer without pop-up waste - Chrome

---

CYO

ST 010 108 7811